

PFTNA logging tools and their contributions to in-situ elemental analysis of mineral boreholes

C.P. Smith,^a P. Jeanneau,^b R.A.M. Maddever,^c S.J. Fraser,^a A. Rojc,^a M.K. Lofgren^a and V. Flahaut^b

^aCSIRO Mineral Resources Flagship, Technology Court, Pullenvale, Australia. E-mail: craig.smith@csiro.au

^bSodern, 20 av. Descartes 94451 Limeil-Brévannes, France. E-mail: philippe.jeanneau@sodern.fr

^cBHP Billiton, 125 St Georges Terrace, Perth WA 6000, Australia. E-mail: Arthur.AM.Maddever@bhpbilliton.com

Historically, the application of nuclear science to borehole logging began with the detection of the natural radioactivity emitted by rocks and soils. This simple and effective method found many applications, particularly in sedimentary, coal and uranium deposits. Whilst this technique is still widely used today, the industry quickly moved to more sophisticated logging techniques that activate rocks with neutrons and measure the induced radiation to infer characteristics of the material surrounding the hole. Neutrons, as primary particles, were found to be an excellent radiation source, which opened large opportunities for in-situ material analyses. Neutron based commercial instruments were introduced¹ for the first time in the 1940's. Early versions of neutron logging tools used isotopic neutron sources that primarily responded to the amount of hydrogen in the formation. These were adopted by the oil industry to identify zones of porosity. Common isotopic neutron sources, such as ²⁵²Cf or ²⁴¹Am-Be, are environmentally problematic if, for any reason, the tool cannot be retrieved from the borehole. Tools using continuously-on isotopic sources also suffer from limited capacity to distinguish between water and oil. Pulsed sources were found to overcome this obstacle since, by exploiting differences in time response, they made it possible to distinguish water from oil beds. Thus, the need for switchable neutron generators was driven by the oil industry, which in turn prompted the development of compact industrial grade equipment suitable for the requirements of their logging tools. There is a variety of active logging techniques based on the use of pulsed neutrons. These can be classified according to the implementation of the neutron source and the type of induced particles that are detected. Among the latter, gamma photons are of considerable interest as they enable elemental analysis of rocks. Pulsed Fast and Thermal Neutron Activation (PFTNA) is one of the most commonly used techniques combining a neutron generator with a gamma scintillation detector. Application of PFTNA for borehole logging is not limited to the oil industry. Nevertheless, most commercial tools have been developed to withstand the severe pressure and temperature conditions inherent at great depths in oil wells and thus tend to be oversized and too costly for mining applications. Without the need to withstand high temperatures and pressures, the technology can be optimized to make it more cost effective. This article presents a new PFTNA tool developed for the mining industry.

PFTNA (Pulsed Fast and Thermal Neutron Activation)

Neutrons interaction for elemental analysis

Pulsed Fast and Thermal Neutron Analysis (PFTNA) is a technique that exploits several nuclear interactions of neutrons with matter in order to identify and quantify a large number of elements. Neutron energies are generally classified according to their kinetic energy into three categories: fast ($E > 1$ MeV), intermediate ($1 \text{ keV} < E < 1 \text{ MeV}$), and slow ($E < 1 \text{ keV}$). This latter category is itself subdivided into epithermal ($0.1 \text{ eV} < E < 1 \text{ keV}$) and thermal ($E < 0.1 \text{ eV}$).

When neutrons penetrate the matter, they progressively lose their energy, mostly as results of successive elastic collisions. Each collision causes the transfer of a percentage of neutron kinetic energy from the incident to the target nucleus. This process is called *slowing down* or *thermalization*, which continues until the neutrons reach thermal equilibrium. Note that neutron particles have a mass nearly the same as hydrogen, making that element the most effective at slowing down neutrons following collision.

Apart from the elastic collision mechanisms, neutrons initiate three main types of interactions that results in the production of secondary particles:²

- Inelastic scattering: A neutron interacts with a nucleus to form a very short lived isotope in an excited state. This returns quickly to its ground state by emitting a gamma ray, then a neutron. The

energy of the incident neutron needs to be above a threshold value specific of the element to initiate the reaction.

- Transfer reaction or Activation reaction: A neutron is absorbed by the nucleus which in turn releases one or more particles.
- Radiative capture: A neutron, once slowed down to thermal energy, is absorbed by a nucleus that reaches an excited state; that nucleus decays nearly instantaneously to the ground state by the emission of one or more gammas. The created isotope may be stable or may be itself radioactive.

Particles (gamma photons in particular) resulting from these interactions are characteristics of the target nuclei; and thus can be used for their identification. Neutron capture and inelastic scattering are the most common interactions exploited in neutron based borehole logging.

A large variety of elements found as constituents of common minerals, such as Si, Fe, Ca, Al and Mg can be measured using gamma rays resulting from neutron thermal capture reactions. Yet a few major elements, such as C and O display virtually no response to slow neutrons. Their direct measurement requires inelastic scattering interactions, which can only be initiated if the source can produce neutrons with sufficient energy to activate such reactions.

The use of energetic neutrons as produced by Deuterium-Tritium generators, for example, enables the excitation of surrounding material with a wide range of energies from thermal to fast, which opens up the opportunity to exploit the different types of reactions.

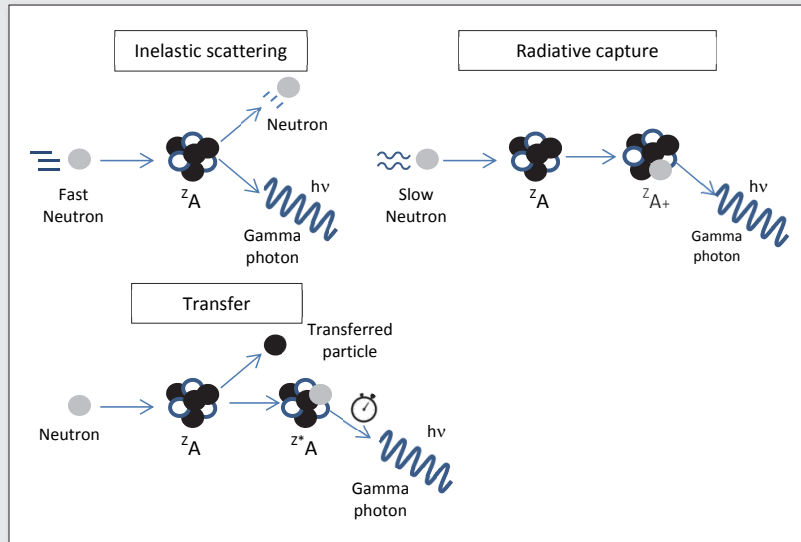

Figure 1. Neutron Interactions with matter

Pulsed electric neutron source

The PFTNA technique relies on a pulsed neutron generator (NG). The principal part of a neutron generator is a small linear particle accelerator, called a neutron tube. Neutron tubes have been built for more than 40 years; and they produce fast neutrons by fusion of hydrogen isotopes³. Two main nuclear reactions are used in standard neutron generators.

- Deuterium ²H – Deuterium ²H (D-D)
 $^2\text{H} + ^2\text{H} \rightarrow ^3\text{He} + ^1\text{n} + 3.266\text{MeV}$ (neutron energy about 2.4 MeV)
- Deuterium ²H – Tritium ³H (D-T)
 $^3\text{H} + ^2\text{H} \rightarrow ^4\text{He} + ^1\text{n} + 17.586\text{MeV}$ (neutron energy about 14.1 MeV)

The yield of the second reaction is about 100 times that of the first. Consequently, it is the DT fusion reactions, which creates high energy 14MeV neutrons, that is more widely used of the two in the manufacture of borehole elemental logging tools.

A typical sealed neutron tube includes an ion source, an accelerating gap and a beam target; all these components are enclosed within a sealed vacuum enclosure. The high voltages for the

accelerator and the ion source are provided by external power supplies. Tritium is impregnated on the target as solid hydride trapped in porous titanium. Deuterium is loaded similarly on a small resistor. A small quantity of gas is released on demand inside the tube by adjusting the current of the resistor. Plasma created inside the ion source produces ions which are accelerated onto the target to initiate DT fusion and neutron production.

The ability to interrupt neutron emission by turning off the power supply provides significant benefits for the use of electrical generators in borehole logging. The most notable is the absence of radiation when the tool is outside the borehole and handled by operators.

But this switchable capability may also be used to control the neutron pulse on a short time scale.⁴ During the pulse of fast neutrons, the gamma ray spectrum is primarily composed of rays from the inelastic and transfer reactions. Between pulses, neutrons lose their energy and can initiate thermal capture reactions. With an appropriate gate circuit, it becomes possible to separate the gamma-ray spectra produced by neutron inelastic scattering from those excited in neutron capture reactions. By further encoding a

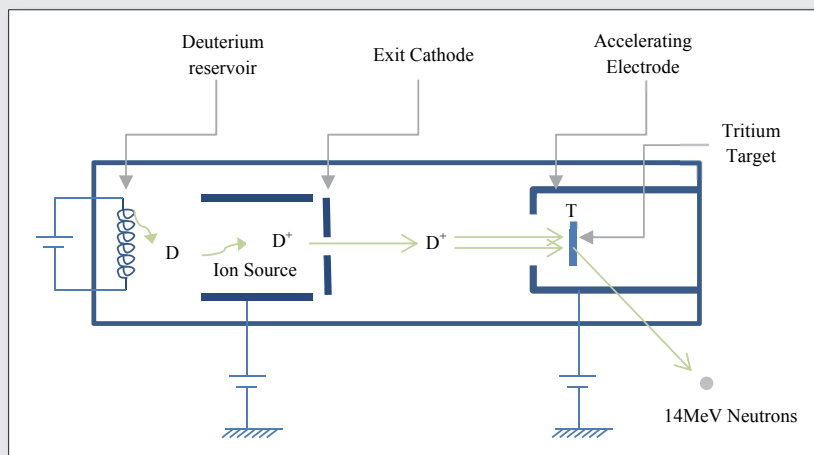

Figure 2. Neutron Tube Principle

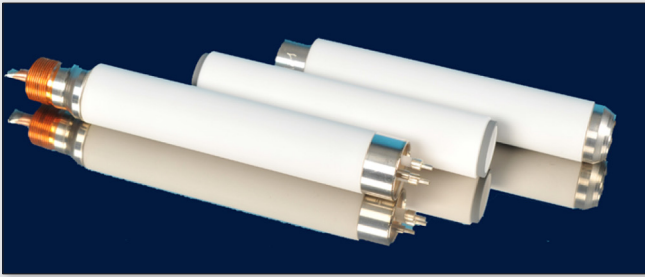

Figure 3. Ceramic body sealed neutron tube – Sodilog by Sodern

delay between the pulse waveforms, it is also possible to store in a separate memory events corresponding to decays of isotopes that may be created.

For some time, pulsed neutron generators have been widely used for oil logging. However, this application required them to be built to withstand high temperature and it is arguable that the associated high cost and reduced life time has limited their penetration into mining industry. Considering much less extreme conditions prevalent in most currently mined hard rock environments having boreholes that do not exceed a few hundreds of meters, commercial manufacturers have since gone to considerable efforts to propose reliable systems with extended life times of several thousands of hours, suitable for industrial mining applications.

High resolution gamma detectors

A spectrometric technique is used to record the energy of the gamma rays emitted by excited nuclei. Commonly found gamma rays detectors in logging tools are made of a scintillation material coupled with a photo multiplier tube (PMT). Incoming gamma particles are absorbed in the scintillator, which re-emits the energy in the form of light. This light is converted into electrons by the PMT photocathode. A series of amplification stages multiplies electrons

to generate an electrical pulse having area or height that is proportional to the energy of the incident photons.

Specialized electronic circuits measure individual gamma photon energies, which build the population histogram. This is referred to as a *pulse heights spectrum*. The incoming gamma rays, originating from the different elements, have discrete and characteristic energies. However, noise and statistical effects in the pulse measurement introduce broadening of the corresponding peaks constructed in the spectrum. With respect to the various mechanisms of interaction between the gamma photons in the scintillator, the pulse heights spectrum is usually a rather complex structure.

Inorganic scintillators are typically used in borehole nuclear logging tools.⁵ Well-known crystals such as NaI, CsI or BGO have been used for decades in both passive and active gamma logging techniques. Crystal choice results in several parameters that influence a tool's analytical performances and its operability. Spectral resolution is one parameter that plays a frequent role. Resolution is defined as the width of the peak at a given gamma energy. An ability to resolve narrow peaks decreases the risk of overlap between closely spaced gamma lines and helps in identification. Because manual processing is usually not sufficient, it also facilitates unfolding algorithms. This capability is of particular interest for the rich spectra composed of thermal capture gamma rays, which contain numerous and overlapping peaks.

Another property of the detector that needs to be taken into account is the scintillator stopping power, which corresponds to the efficiency of the crystal to interact with incoming photons. The higher the energy range of gamma photons, the more transparent will be the scintillator. Capture gamma rays produced by elements typically targeted in borehole logging, such as Si, Fe, Ca, Al and Mg, have energies above 3MeV, and up to 10MeV, which requires rather dense crystal to generate sufficient signal. Conversely, gamma rays created by inelastic scattering reactions with carbon and oxygen are rather sparse, and can be easily detected and identified by most crystals. However, for inelastic scattering reactions,

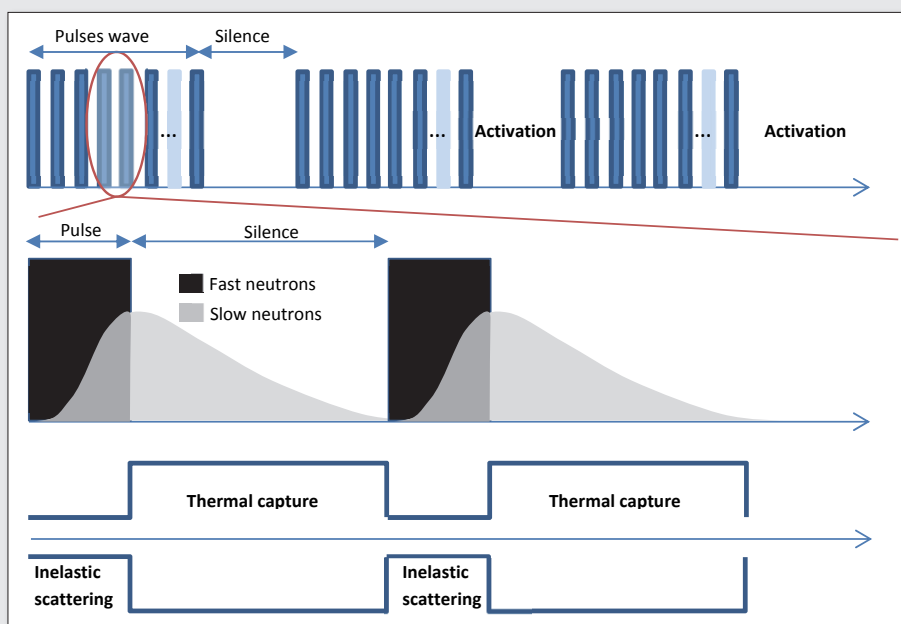

Figure 4. Pulse fast and thermal neutron analysis sequence

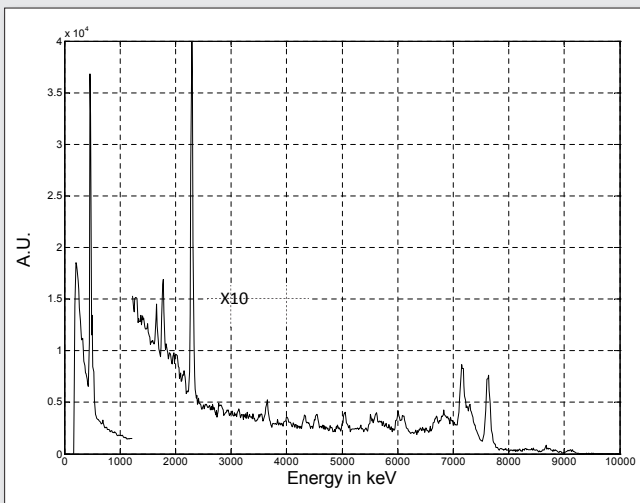

Figure 5. Spectrum from bromium lanthane detector LaBr_3 – iron ore – Thermal capture reactions

event-rates during the neutron burst are high, so scintillators exhibiting short durations of the pulses of light are preferred.

Beyond fundamental physical parameters, the sensitivity of the detector to operating conditions, including temperature and other environmental factors, plus economic considerations, are also usually taken into account. This leads the PFTNA logging tool designers to a trade-off that usually results in the adoption of BGO as a compromise; the down-side being relatively poor energy resolution and sensitivity to temperature, potentially limiting the performances of such systems.

A breakthrough has taken place since early 2000 with the market availability of a new crystal, Cerium-doped lanthanum bromide, $\text{LaBr}_3(\text{Ce})$.⁶ This crystal offers both excellent energy resolution and a fast response. Further, it has a density that makes it usable for high energy gammas and low sensitivity to temperature variation. Consequently, this crystal has now become a viable solution for PFTNA logging tools.

PFTNA logging tool development for mining industry

PFTNA logging tools have been used in oil logging for a long time, however, their use in the mining industry has remained quite limited until now. This is partly to do with the fact that oil logging tools are generally oversized and over-engineered for the mining application and partly because the high cost of development tends to be prohibitive, even for the larger mining corporations.

Hence the approach that we followed in developing a new PFTNA logging tool was to design it compatible with current operating procedures, field conditions and borehole characteristics common to ore extraction sites and, subsequently, through testing and analysis, to refine. A robust tool was designed based on these guidelines, so that it would be cost effective for implementation in coal and minerals mining activities. The development was undertaken jointly by three parties. Sodern, an Airbus company, having knowledge in design of compact sealed neutron tubes and neutron generators and how to incorporate them into neutron based industrial cross-belt analytical systems; the Commonwealth Scientific and Industrial Research Organisation (CSIRO) having deep experience in the

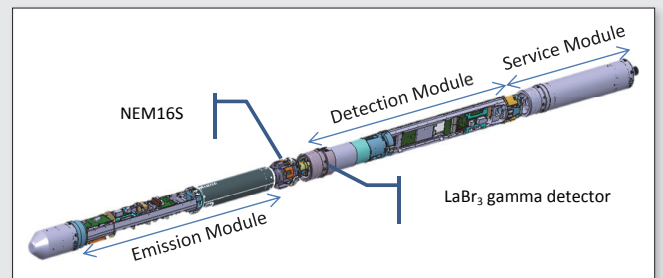

Figure 6. CAD view of the FastGrade™100 logging tool

design of nuclear logging tools,^{7,8} who took responsibility for power, communications and overall implementation of the tool in the end user's logging environment; BHP Billiton, a mining company and the primary end user, who funded the development and provided the end-user specifications in addition to feedback and experience gained from thousands of kilometres of drilled and logged boreholes.

The new tool called FastGrade™100 (FG100) is primarily aimed at measuring boreholes drilled for exploration and resource estimations. This tool has been extensively tested in the Western Australian Pilbara iron ore mining district.

A diameter of 4 inches (101.6mm) was agreed for the logging tool, enabling it to fit with sufficient clearance inside 140mm diameter (and larger) holes commonly drilled on sites using reverse circulation (RC) drilling.

The overall length of the probe lowered inside the holes is about 3.3m. It is divided into 3 major sub modules:

- The Emission Module (EM)
- The Detection Module (DM)
- The Service Module (SM)
- The probe is connected to the surface using a regular 4 wires steel reinforced cable. The surface station is composed of:
 - The Uphole Control Box
 - The Uphole Control Computer and,
 - A set of peripheral equipment used for radiation monitoring, geo-location and user-informative safety devices.

Each downhole module is individually housed in a steel metal barrel that connects them all together. Once assembled the tool can be used in dry, or water-filled boreholes and is certified for pressure up to 40bars.

Emission Module

The heart of the neutron emission subsystem is a Sodern sealed neutron tube called *Sodilog*¹¹. The *Sodilog* tube is a miniature particle accelerator having a ceramic body. Originally designed by Sodern on request from oil logging companies, the *Sodilog* tube is now a proven technology that is produced in large quantities by Sodern for more than 15 years. The neutron tube is enclosed in a metal housing called Neutron Emitting Module (NEM), which is filled with SF_6 dielectric gas to insulate the high voltage elements of the tube from its surrounding.

The NEM is connected to a compact very high voltage (VHV) power supply providing up to 120kV for accelerating ions to the tritiated target. A separate pulsed power supply is connected to the ion source to create neutrons bursts with accurate and adjustable timing structure. Although the neutron timing must respect the

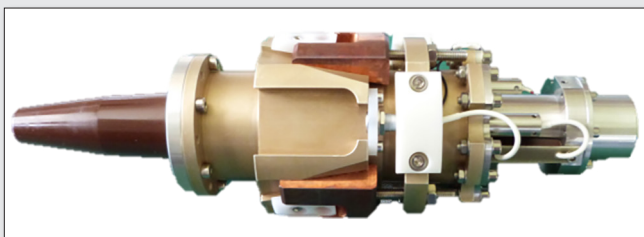

Figure 7. Compact Neutron Emitting Module – NEM16S

underlying physics, it has sufficient flexibility to allow optimisation of gamma rays scattering effects related to inelastic and thermal capture.

Detection module (DM)

The Detection Module accommodates a 3 x 4 inch $\text{LaBr}_3(\text{Ce})$ scintillation crystal. Selected for its intrinsic high performance, the detector is connected to a fully digitized acquisition and pulse-heights processing boards. The system is gated to measure individual timing windows synchronized with the neutron pulsing mechanism. The gamma rays from the different nuclear reactions are recorded in separate 1024 channels, one each for inelastic scattering, thermal capture and delayed activation. These are stored and made available to end users as well as being passed to the data processing module. Combining the fast response time of the crystal with the high speed FPGA processing components, minimizes dead time and enable acquisition times down to a few seconds.

Service Module (SM)

The Service Module was designed as the communication and power interface for the logging tool. Power is provided from the surface to the SM via a 240VAC power link on two of the wireline conductors; communications are supplied on the other two. The power is converted into 12V and 48V before delivery to all down-hole components.

Communication to the surface is based on VDSL digital communication over twin conductors. A proven technology largely deployed in industrial data network, VDSL easily covers the bandwidth requirements of the tool and allowed implementation of affordable commercial solutions. Communication from surface to tool was successfully tested down to depths of 650m. Reliable and straightforward, it enables the set-up of an Ethernet network connecting all downhole and uphole modules. This approach exemplifies the

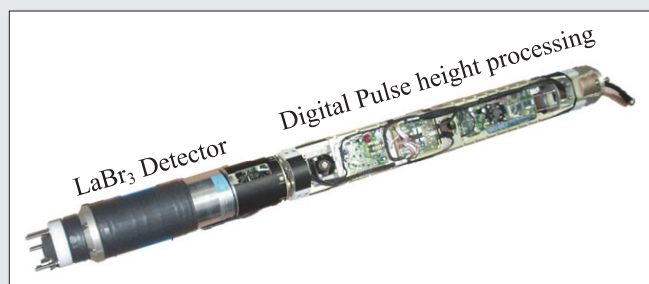

Figure 8. Detector Module – view LaBr_3 and digital processing electronic board

design philosophy of building system components whenever possible using non-specific off-the-shelf technology.

Uphole Control Box (UHCX)

The Uphole Control Box is the surface counterpart of the service module; it manages power, communication and data transfer. Beyond this, it also ensures safe operation of the equipment. Design protocols prevent it from allowing users to bypass any of the safety interlocks and, in the event of a hazardous situation, it will take advantage of the switchable nature of the neutron generator to turn off the probe in order to provide occupational safety for operators.

Cable connection and integrity to the tool is routinely tested before allowing any power to be applied. Loss of communication with the tool or the UCB will result in power to the tool being automatically disconnected, resulting in a complete shutdown.

The UCB provides interfaces to the logging vehicle, of particular importance being winch signals for depth, speed and directional information. The box supervises an on-board and independent radiation monitor and, in case of an alert, it will remove power from the tool and activate an alarm.

Uphole Control computer (UCC)

The Uphole Control Computer (UCC) is the user-interface to the logging tool. It enables the user to control and monitor all aspects of the tool operation such as depth, status of the safety loop, control of the neutron generator and acquired spectra.

The user interface has been defined in close cooperation with logging operators. In effect, this led to a single graphical page tailored to the strict minimum of necessary items to perform logging operations safely and reliably. More comprehensive diagnostic information on the tool status is available under various tabs on the interface.

The logging operation produces a file, written in HDF5 format. It contains, for each depth interval, the three different types of gamma spectra, as well as the detailed experimental conditions applying during the acquisition, such as voltages, currents, temperatures and GPS location. Elemental concentration as a function of depth may also be included provided a suitable calibration has been uploaded into the UCC.



Figure 9. Uphole Control Box

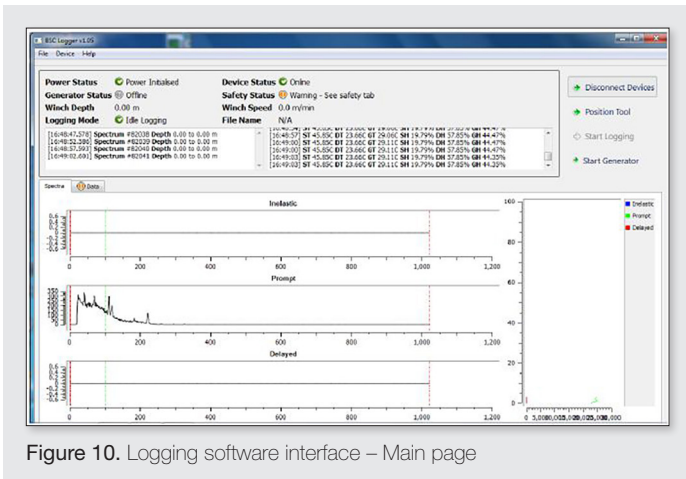

Figure 10. Logging software interface – Main page

An important requirement from miners is that, with these data, the end-user can recreate all aspects of the logging environment and be able to confirm, correct or update results later, when individual logs are merged and consolidated into 3D models using mine planning software.

Integrated System

The tool is integrated onto a dedicated logging vehicle. Handling operations have been mechanized and the tool can be taken out and positioned above a borehole, all by remote control. In this way, a single operator can drive the vehicle to the designated location and undertake a PFTNA log.



Figure 11. Equipped logging vehicle and FG100 handling

The tool is usually lowered to the desired lower depth of the targeted log section. The tool is then switched “on” to enable neutron emission. The tool is lifted and the system then automatically records gamma spectra. Operated at 2m/min, measurements are recorded every 6s, providing elemental data for each 20cm intervals.

With the intent to provide a new generation of logging tools suitable for the mineral industry, a PFTNA probe has been designed and manufactured. A neutron pulse generator from Sodern has been used on the basis of it being proven long life technology. To achieve optimum gamma spectrometry, the tool incorporates among the best industrial detectors. The remainder of the tool has been intentionally designed using purpose-built technology and off-the-shelf solutions suitable for the mining environment to strike the right balance between cost and reliability. Specifically designed with the end-user logging operator in mind, the software and electronics provides easy to use tools without any compromise in safety.

PFTNA and sampling methods

Neutrons and gamma rays exploited by PFTNA techniques are energetic particles. Consequently, neutrons are able to penetrate the surrounding material to considerable depth, following which the resulting gamma photons are able to reach the detector even through several tens of centimetres of bedrock. In a borehole logging configuration, the collected PFTNA signal, and the derived elemental composition, will be representative of a much larger volume of surrounding material than the delimited volume of the core material that is traditionally used to provide chemical analysis. This larger volume is the key that enables better sampling statistics and improved reliability in resource estimation using the PFTNA approach, especially when heterogeneous deposits are explored.

PFTNA provides several additional advantages that make it attractive when compared to the traditional approach based on material collected as part of a drilling operation followed by laboratory analysis:

- Whatever traditional sampling methods and equipment are used to sample borehole material, it is recognized that sample and core sample recovery is rarely complete, which limits its representativeness and introduces some level of sampling error.
- The PFTNA technique is also less sensitive to certain material physical parameters, such as density and mineralogical forms of rocks constituents. It therefore does not require the critical steps of material preparation that conventional laboratory techniques do.



Figure 12. Open holes RC drilling collected samples

■ Even when applying sophisticated algorithms, modern computers are capable of processing PFTNA spectra within a few seconds and can provide analytical results as soon as they are received during logging. Rapidly available analytical data is a strong advantage compared with the conventional sampling and assaying approach that extends at best over days and more commonly over weeks.

As a consequence, the PFTNA technique, embodied in the FG100, seems to offer an excellent alternative solution for the mining industry, eliminating the well-known obstacles caused by sampling and sample preparation, while being affordable and leading to substantial reductions in cost and time. However, proposing PFTNA for in-situ measurements as an alternative to traditional chemical analysis may at times be overly-simplistic. For one thing, such a proposal ignores the fact that a laboratory can deploy several different techniques that not only provide elemental analysis, but also a variety of information that PFTNA alone will not be able to measure, such as hardness, grain distribution and crystalline structure.

For another, whilst PFTNA offers acceptable analytical detection limits for a large panel of elements of interest found in minerals, such as Si, Ca, Fe, Al, Mg, the base metals Cu and Ni and even light elements as H, C, and O, it will not necessarily achieve the required performance for trace elements. On occasions, these might be major indicators of ore quality, such as P in iron ore, or ppm levels of valuable elements, such as Au and Ag in some copper deposits. Consequently laboratory analysis of samples and PFTNA in-situ elemental logging should be considered complementary methods and implemented accordingly.

Of the two methods, the greater volume of material measured with PFTNA is an advantage, but it should not be idealized. At face value, it can be roughly assumed that the sample volume is a factor of 10 greater for the FG100 logging tool. However, the response function of the system is a complex convolution of the different nuclear phenomena that underlie the PFTNA theory. Neutrons emitted from the source will be spatially distributed in the material according to the slowing-down effect. To first order, this will define a population of neutrons that changes in quantity and energy with the distance from the source. This is modified by a second-order effect that takes account of local material characteristics. Similarly, the gamma photons subsequently created at each point in space will be measured by the detector according to a collection efficiency function that is also dependent on the distance to the detector and the characteristics of the material that the gamma rays traverse on their way to the detector. Thus, the signal produced by the collection of volume elements surrounding the tool results from the convolution of those effects and each volume element will be weighted differently in the sum spectra that is processed to infer an overall elemental composition.

During the development of the FG100 logging tool, the measured volume was investigated in details. Experimental evaluation (supposing that this would make sense) was not considered achievable for reasonable effort. Conversely, the use of Monte Carlo simulations was straightforward and allowed possibility of virtually inspecting the signal characteristics inside the material^{9,10}.

The simulation work has consisted of estimating how the tool spatial response function is influenced by variations in material physical properties as well as by specific operating parameters, such as rock density, moisture content and borehole diameter.

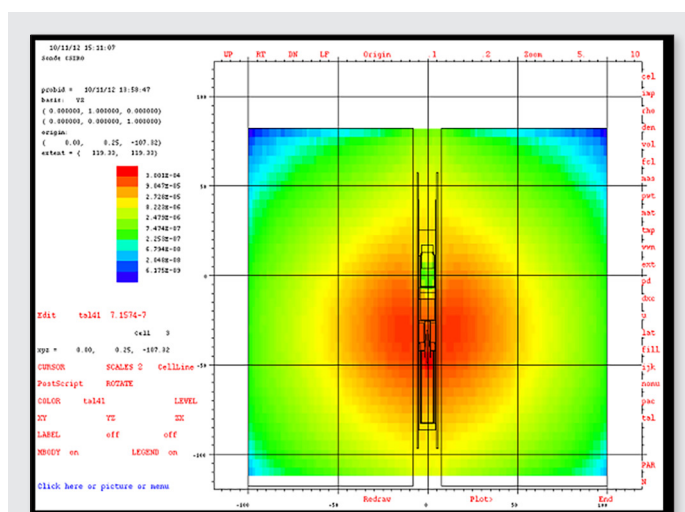

Figure 13. Thermal neutron distribution in the surrounding material obtained by Monte Carlo simulations

The framework for the simulation was a Western Australia iron ore deposit. The volume of material interrogated by the tool was found to vary significantly when the composition of the material varied widely. This was also the case when there was significant change in borehole characteristics along the few hundreds of meters of a typical log. For example, it was found that water-filled cavities in boreholes may reduce the penetration by up to a factor 2 compared to when dry.

To some extent, these “poor log recovery” events compare to and are similar to “core loss” or poor sample recovery during drilling programs with similar consequences and increased uncertainty that is then added to the compositional estimates for the corresponding depth interval. However, works undertaken during development of the FG100 PFTNA tool enabled to identify some mitigation possibilities. Although calibration of the PFTNA tool is primarily intended to account for elemental variations, it was found that calibration could also incorporate algorithms that compensate for a variety of influencing effects. Multiple calibrations can also be established when conditions of use exhibit great difference, allowing optimized models to be developed that accommodate significant change of material or measurement conditions. This work remain exploratory, however, it is expected that Monte Carlo simulations can be used to refine the signal processing, offering the potential to extend the calibration base without requiring an intensive additional sampling campaign.

Conclusion

Pulsed Fast and Thermal Neutron analysis is a nuclear technique that can be applied to borehole logging. The technique is used for the in-situ and direct determination of elemental concentrations of material surrounding the hole. It takes advantage of a switchable pulsed neutron generator, overcoming the most significant limitation attached to traditional permanent isotopic sources. This makes PFTNA technique inherently safer and significantly improves occupational safety on site. Due to the deep penetration of neutrons and gamma rays, the technique is suitable for logging applications. Proven equipment is available for both emission of neutrons and detection of gamma rays. A next generation tool has been designed and produced with the aim of promoting it to industries such as

coal and other mineral commodities. The FG100 tool is built around the latest in technology for optimal spectrometric measurement. Notwithstanding this, the overall approach is intentionally oriented toward using components and technology widely established but specified for ore deposit logging conditions. All aspects have been considered for taking the instrument up to an industrial grade with the expected level of reliability and safety. The new tool has started making inroads in the iron ore industry where it can play a key role in the early phase of resource evaluation. The benefit of having in-situ, real time, chemical analysis will likely lead the industry to reconsider the current approach based on samples collection and laboratory analysis, although it is acknowledged that the latter will remain the method of choice for certain situations. We can expect future tactics will consider how the two methods could complement each other. Some improvements have been identified for future consideration. They primarily concern the calibration, particularly efforts to streamline this essential step. Also, further data processing work is foreseen to extract still underexploited information from the spectrometric data.

References

1. B. Pontecorvo, *Neutron Well Logging – A New Geological Method Based on Nuclear Physics*, Oil and Gas Journal 40: 32–33. 1941
2. P. Rinard, *Neutron Interactions with Matter*, Los Alamos Technical Report <http://www.fas.org/sgp/othergov/doe/lanl/lib-www/la-pubs/00326407.pdf>
3. *Neutron Generators for Analytical Purposes* IAEA RADIATION TECHNOLOGY REPORTS No. 1
4. Alexander P. Barzilov, Ivan S. Novikov and Phillip C. Womble (2012). *Material Analysis Using Characteristic Gamma Rays Induced by Neutrons, Gamma Radiation*, Prof. Feriz Adrovic (Ed.), ISBN: 978-953-51-0316-5, InTech, DOI: 10.5772/36372, <http://www.intechopen.com/books/gamma-radiation/material-analysis-using-characteristic-gamma-rays-induced-by-pulse-neutrons>
5. M. Borsaru, Selected topics in nuclear geophysics, Proceedings of the Romanian academy, Series A, Volume 6, Number 3/2005, http://www.acad.ro/sectii2002/proceedings/doc_2005_3/03-Borsaru.pdf
6. E. V. D. van Loef, P. Dorenbos, C. W. E. van Eijk, K. Krämer and H. U. Güdel, *High-energy-resolution scintillator: Ce3+ activated LaBr3*, Appl. Phys. Lett. 79, 1573 (2001)
7. M. Borsaru and J. Charbucinski, *Nuclear borehole logging techniques developed by CSIRO – Exploration and Mining for in situ evaluation of coal and mineral deposits*, Proceedings of the Second international conference on isotopes, 1997 http://www.iaea.org/inis/collection/NCLCollectionStore/_Public/29/057/29057219.pdf
8. K. Trofimczyk, S. Saraswatibhatla, C. Smith, *Spectrometric Nuclear Logging as a tool for real-time, downhole assay – Case Studies using SIROLOG PGNA*, 11th SAGA Biennial Technical Meeting and Exhibition Swaziland, 16–18 September 2009, pages 161–171
9. LANL X-5 Monte Carlo Team, MCNP-A General Monte Carlo N-Particle Transport Code, Version 5, 2003.
10. Fusheng Li and Xiaogang Han, *Monte Carlo Numerical Models for Nuclear Logging Applications*, SYSTEMICS, CYBERNETICS AND INFORMATICS VOLUME 10 – NUMBER 3 – YEAR 2012
- 11 http://www.sodern.com/sites/docs_wsw/RUB_78/Fiche_Sodilog.pdf